

ILER-40

SSB QRP Transceiver Kit

Assembly Manual

Last review October 01, 2013

ea3gcy@gmail.com

Latest updates and news: www.qsl.net/ea3gcy

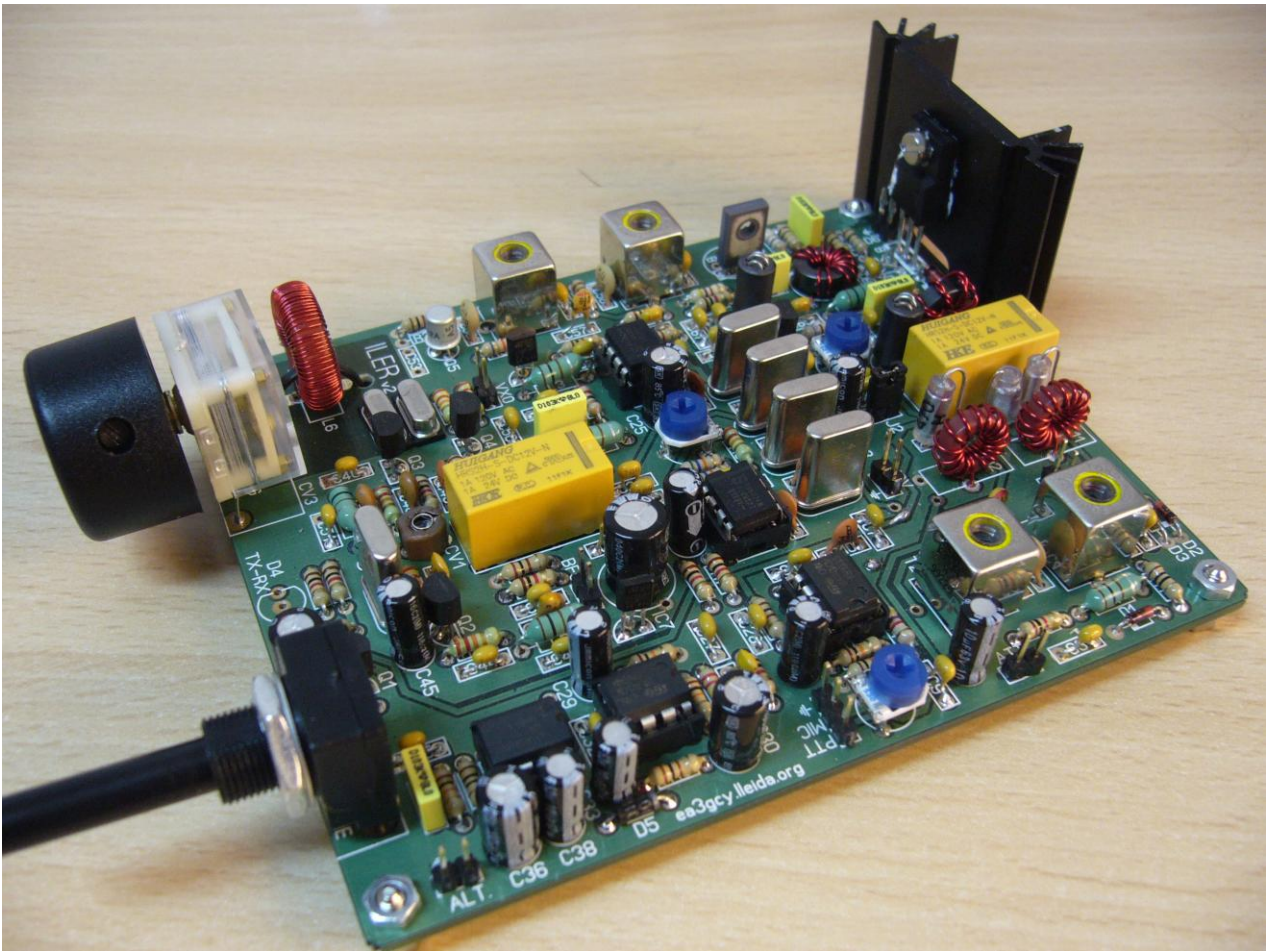

Thanks for purchasing the “ILER-40” Kit SSB Transceiver

Fun building, enjoy QRP ! 73 Javier Solans, ea3gcy

CONTENTS

CONTENTS.....	2
INTRODUCTION.....	3
SPECIFICATIONS.....	4
TIPS FOR FIRST TIME BUILDERS.....	5
VALUE/QUANTITY COMPONENT LIST.....	7
INDIVIDUAL COMPONENT LIST.....	9
120 QUADRANT MAP.....	13
ASSEMBLY.....	14
TESTING AND ALIGMENT.....	26
ANEXXES.....	31
IF YOUR KIT DOES NOT WORK AFTER FINAL ASSEMBLY.....	34
Limited WARRANTY.....	35
SCHEMATIC.....	36
WIRING.....	37

INTRODUCTION

ILER why ? A bit of history...

The origin of LLEIDA goes back to the V b.c. when the people of the Iberian Ilergetas settled on top of Seu Vella hill and founded the city of ILTIRDA. His best-known leaders were Indibil and Mandonio, which fought against the Carthaginians and Romans, however, were defeated in 205 b.c. and thereafter the city and renamed Romanized ILERDA.

LLEIDA is the actual name of this city in northeastern Spain.



Photo: Seu Vella of Lleida.

ILER-40

This kit is one of the many simple transceiver circuits that work with the famous NE602 integrated circuit work reversibly. The circuit of ILER-40 is a Spanish 40M redesign of "Antek 80M" transceiver from Andy (Andrzej Janeczek) SP5AHT published in the "Swiat Radio" magazine, that switching OL and BFO to each of the NE602 to achieve two functions depending on TX or TX. A NE602 works as RX mixer and DSB generator and the other NE602 works as TX mixer and SSB demodulator. Legendary TOKO coils "KANK3334 (5u3H)" are used for independent Tx and Rx band-pass filters. Also included Rx antenna input attenuator to avoid over-modulation from very strong signals.

High stability VXO oscillator tunes 30-100Khz segment and offer very low drift: from cold start 150Hz or less during 5 minute warm up (50-60KHz segment).

¡A strong and oversized transmitter design, to resist and hard work in the field!

The philosophy for equipment has been:

"Having just the bare minimum to make it work, ¡and works OK!"

Only two controls: volume and tuning, more than enough to fully enjoy the pleasure of QRP !

Acknowledgements

Thanks to Andy SP5AHT for his important contribution in the amateur radio world.

Thanks to Jon Iza, ea2sn for his invaluable help in locating errors and improving the manual and verification and reporting of technical data.

To Luis ea3wx, Juan ea3xf, Jaime ea3hfo, Alfonso ea3bfl and J. Antonio Beltrán for his encouragement and insistence received to make this kit.

To "eaqrclub.com" to keep the flame of "Homebrew" even in difficult times.

SPECIFICATIONS

GENERAL:

Frequency Coverage: VXO tuning 30-100KHz segment in 40M band. Bandwidth range is selected according L6 value in the VXO circuit. Is possible increased coverage, but does not allow a comfortable tuning (without fine tuning).

Frequency control: high stability VXO oscillator. Option A: two crystals 12.031MHz. Option B: one crystal 12.096MHz. With variable capacitor control (polyvaricon).

Antenna: 50 ohm

Power requirement: 12-14VDC, 35mA. Receive (no signal), 100mA max. receive, 800-900mA on transmit.

Board-mounted components: 51 resistors, 77 capacitors, 3 resistors trimmers, 1 trimmer capacitor, 1 potentiometer (volume), 9 IC's, 8 transistors, 7 diodes, 12 inductors-coils, 6 RF transformers, 1 tuning polyvaricon, 7 crystals.

Front panel controls: tuning, volume.

Rear controls: Rx Attenuator switch

External connections: microphone/ptt, phone jack, antenna, DC input.

Board size: 100x120 mm.

TRANSMITTER:

RF Output: 4 – 5 watts pep (12-14V)

Output 2^o harmonic: -42dB

Other signals spurious: -50dB or better

Carrier suppression: better than -35dB

T/R Switching: PTT relay

Mike preamp & passband

Mike Type: dynamic 600ohms, CB or similar OK (no included)

RECEIVER:

Type: single conversion superheterodyne, balanced mixer

Sensitivity: 0.200uV minimum discernible signal

Selectivity: 4 pole crystals ladder filter (2,2KHz nominal bandwidth)

IF frequency: 4.915Mhz.

Audio preamp & audio SSB filter

Audio output: 250mW @ 8 ohms

PLEASE READ ALL THE PAPERWORK THROUGH AT LEAST ONCE BEFORE STARTING WORK

TIPS FOR FIRST TIME BUILDERS

Tools Required:

- Small tipped soldering of about 25-30W rating, small side cutters, wire strippers, long strippers, long nosed pliers, a sharp knife hobby cutter, a screw driver for the M3 bolt, trimming tool for Toko coils.
- You need a good light and a magnifying glass to see fine print on the parts.

Instruments Required:

- Multimeter, Oscilloscope (desirable not essential), Frequency Counter or HF receiver, RF power meter, 5W-50ohms load, RF Generator (desirable not essential).

Soldering:

There are two important things which need to be done to ensure the successful operation of a kit. One is getting the right part into the proper place on the board. The second is good soldering.

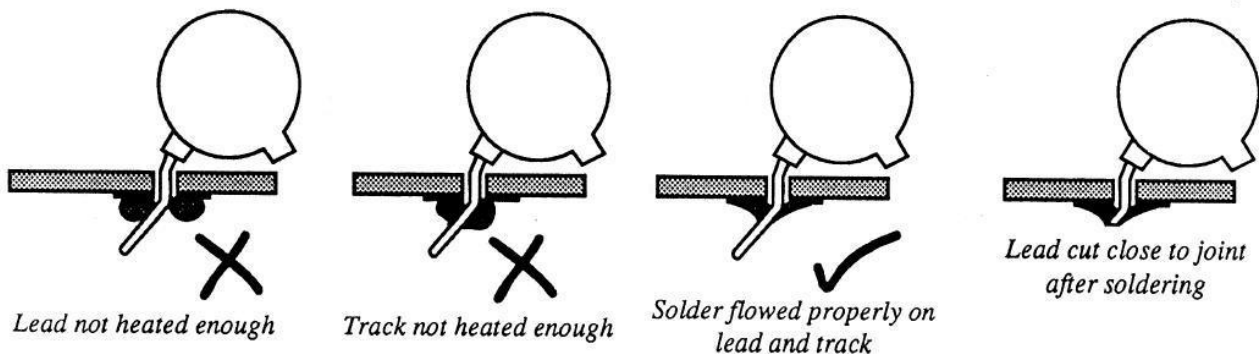

To solder properly, you must use the correct type of iron and the right quality of solder. Use a small tipped soldering iron which has a bit that is short and almost pointed at end. The iron should be about 25-30 Watts (if it is not thermostatically controlled). Only use electronic type multicore solder. NEVER use any extra flux. You should hold the hot iron in contact with both the board and component lead for about two seconds to heat them up. Then, keeping the iron in place, touch the solder onto the junction of lead and track and wait about two second or so until the solder to flow along the lead and track to form a good joint. Now remove the iron. The iron should have been in contact with the work piece for a total time of about 4 seconds in all. It is a good idea to drag the tip of the iron up the component lead as you remove it from the joint, this helps to pull any excess solder up with it and encourages good flow along the component lead.

Finding the right part:

IC's

The outline on the board for the ICs has a "U" notch on one end. This indicates the pin 1 end of the IC. There is also a notch on one end of the sockets. This end goes over the "U" notch outline on the board. Finally, pin 1 of the IC is marked with a round dimple or dot. This end of IC will go towards the notch on the socket or "U" on the outline.

Diodes

Be sure to observe proper polarity of diodes. There is a black band towards one end of the diode. This band should face the line shown on the diode outline of the board.

Electrolytic capacitors:

These must be installed with the correct polarity. The positive (+) lead is always the long lead. The negative (-) lead is marked by a stripe on the body of the capacitor can. Make sure the plus end of the cap goes toward the hole labeled with the (+).

Coils and Transformers:

You can find it convenient to wind and prepare all the coils and transformers before you start inserting parts. That way you don't need to stop and possibly lose concentration to wind them.

Is the part of the build considered by some to be the most difficult. I find it one of the easiest stages, personally, and almost relaxing. Just take your time. The assembly instructions and pictures illustrate the process.

VALUE/QUANTITY COMPONENT LIST

Resistor list				
Qty	Value	Checked	Ref.	Identified
4	1		R38, R44, R46, R47	brown-black-gold
2	10		R1, R21	brown-black-black
1	22		R12	red-red-black
1	47		R43	yellow-violet-black
5	100		R11, R18, R26, R37, R39	brown-black-brown
1	270		R45	red-violet-brown
2	470		R33, R42	yellow-violet-brown
12	1K		R2, R7, R13, R14, R25, R29, R34, R40, R41, R48, R49, R50	brown-black-red
1	1K2		R32	brown-red-red
1	1K5		R20	brown-green-red
1	4K7		R4	yellow-violet-red
1	6K8		R35	blue-gray-red
7	10K		R3, R5, R15, R16, R19, R22, R51	brown-black-orange
7	22K		R10, R23, R24, R27, R28, R30, R31	red-red-orange
2	56K		R8, R9	green-blue-orange
1	180K		R6	brown-gray-yellow
1	220K		R17	red-red-yellow
2	5K		P1, P2 ajustables	502 or 53E
1	500		P4 ajustable	501 or 52Y
1	10K		P3 pot. Shaft (volume control)	10K

Capacitor list				
Qty	Value	Checked	Ref.	Identified
30	100n		C1, C3, C7, C9, C12, C14, C20, C23, C24, C27, C28, C32, C35, C40, C44, C46, C51, C54, C55, C59, C60, C64, C65, C66, C67, C68, C70, C71, C72, C77	104 or 0.1
5	10n		C26, C37, C62, C63, C69	103 or 0.01
5	1n		C2, C43, C50, C52, C61	102 or 0.001
1	1n		C75 Styroflex	1000
1	560p		C31	n56 or 561
2	470p		C74, C76 Styroflex	470
1	330p		C10	n33 or 331
4	220p		C21, C22, C41, C42	n22 or 221
2	100p		C47, C48	101
4	82p		C4, C6, C56, C58	82P
1	47p		C49	47P
5	33p		C15, C16, C17, C18, C19	33p or 33J
2	8p2		C5, C57	8P2
1	220uf		C39 (elec.)	220uf 25v or 35V
4	100uf		C25, C30, C34, C36 (elec.)	100uf 25V or 35V
7	10uf		C8, C11, C29, C33, C38, C45, C73 (elec.)	10uf 25V or 35V
1	1uf		C13 (elec.)	1uf 25V, 35V or 63V
1	60p		CV1 Murata trimer BFO	brown
1	160p 70p		CV2+CV3 Polyvaricon dual gang. Tuning. 160p + 70p	

Semiconductors list				
Qty	Type	Checked	Ref.	Identified
Transistors				
5	BC547		Q1, Q2, Q3, Q4, Q8	BC547
1	2N2222		Q5	2N2222
1	BD135		Q6	BD135
1	2SC1969		Q7, washer and mica spacer	C1969
Integrated circuits				
2	LM741		IC1, IC4	LM741CN or UA741
2	SA/NE602		IC2, IC3	SA602AN or NE602AN
1	LM386		IC5	LM386N-1
1	78L05		IC9	MC78L05
1	78L06		IC6	MC78L06
2	78L08		IC7, IC8	MC78L08
Diodes				
3	1N4148		D1, D2, D3	4148
2	1N4001(7)		D5, D6	1N4001 or 1N4007
1	47V		D7, Zener 47V 1W	BZX85C47
1	LED		D4, bicolor Led	-

Inductors/RF Transformers list/Crystals/Relays				
Qty	Value	Checked	Ref.	Identified
6	100uH		L1, L2, L3, L5, L7, L9 Axial inductor	brown, black, brown
1	39uH		L4 Axial inductor	orange, white, black
2	VK200		L8, L10	Choque
2	T37-2		L11, L12 LPF toroids	X mm diam. Red
1	T68-2		L6 Toroid. Tuning inductor	X mm diam. Red
4	3334 (5u3H)		T1, T2, T3, T4 KANK3334 Toko coils or 5u3H	K3334 or "5u3H"
2	FT37-43		T5 toroid 10t+10t ; T6 toroid 12t - 3t	X mm diam. Black
5	4.915		X1, X2, X3, X4, X5 Crystals 4.915MHz.	4.915
2/1	12.031/ 12.096		X6, X7 12.031MHz crystals or X7 12.096MHz X6 none	12.031 or 12.096
2	Relays		RL1, RL2	-

Hardware				
Qty	Value	Checked	Ref.	Identified
5	nuts		hex nuts M3	-
4	spacers		5mm spacer for M3 screw	-
4	screw		5mm M3 screw	-
1	screw		10mm M3 screw	-
1	washer		M3 lock washer	-
23	pins		Mic, 12V, ATT, ANT, ALT, D6, VXO, BFO, J1, J2, T	-
2	jumper		jumpers for J1 and J2	-
5	IC socket		IC's socket 8 pin	-
1	Shaft Poly.		6mm Shaft Polyvaricon Hardware	-
1	Heatsink		Q7 (Output Amp) Heatsink	-
110cm	wire		110cm enameled copper wire 0,5mm	-
115cm	wire		100cm enameled copper wire 0,3mm	-
1	ILER V2 PCB		100mm x 120mm ILER V2 PCB	-

INDIVIDUAL COMPONENT LIST

Resistors						
Checked	Ref.	Value	Ident./Comment	Circuit section	Located	
	R1	10	brown-black-black	Rx attenuator	B-10	
	R2	1K	brown-black-red	Rx attenuator	C/D-10	
	R3	10K	brown-black-orange	Mic preamp	F-9	
	R4	4K7	yellow-violet-red	Mic preamp	E-9	
	R5	10K	brown-black-orange	Mic preamp	F-9	
	R6	180K	brown-gray-yellow	Mic preamp	F-8	
	R7	1K	brown-black-red	Mic preamp	G-7	
	R8	56K	green-blue-orange	DSB gen / Rx mix	F-6	
	R9	56K	green-blue-orange	DSB gen / Rx mix	F-5	
	R10	22K	red-red-orange	DSB gen / Rx mix	E/F-5	
	R11	100	brown-black-brown	Mic preamp	G-8	
	R12	22	red-red-black	SSB Dem / Tx mix	G-3/4	
	R13	1K	brown-black-red	SSB Dem / Tx mix	G-7	
	R14	1K	brown-black-red	Audio Preamp	G-9	
	R15	10K	brown-black-orange	Audio Preamp	H-8	
	R16	10K	brown-black-orange	Audio Preamp	H-9	
	R17	220K	red-red-yellow	Audio Preamp	H-9	
	R18	100	brown-black-brown	Audio Preamp	I-10	
	R19	10K	brown-black-orange	Audio Mute	L-7	
	R20	1K5	brown-green-red	Audio Mute	L-6	
	R21	10	brown-black-black	Audio Amp	K-9	
	R22	10K	brown-black-orange	Audio Amp	K-9	
	R23	22K	red-red-orange	BFO	J-7	
	R24	22K	red-red-orange	BFO	J/K-6	
	R25	1K	brown-black-red	BFO	I-6	
	R26	100	brown-black-brown	BFO	I-6	
	R27	22K	red-red-orange	VXO	I-3	
	R28	22K	red-red-orange	VXO	J-4	
	R29	1K	brown-black-red	VXO	J-4	
	R30	22K	red-red-orange	VXO	I-3	
	R31	22K	red-red-orange	VXO	I-4	
	R32	1K2	brown-red-red	VXO	I-4	
	R33	470	yellow-violet-brown	VXO	I-4	
	R34	1K	brown-black-red	Pre Driver	G-2	
	R35	6K8	blue-gray-red	Pre Driver	H-2	
	R36	NO	not used	Pre Driver	I-1	
	R37	100	brown-black-brown	Pre Driver	I-1	
	R38	1	brown-black-gold	Pre Driver	F-1	
	R39	100	brown-black-brown	Driver	E/F-3	
	R40	1K	brown-black-red	Driver	E/F-2	
	R41	1K	brown-black-red	Driver	D-2	
	R42	470	yellow-violet-brown	Driver	D-2	
	R43	47	yellow-violet-black	Driver	C-1	
	R44	1	brown-black-gold	Driver	B-1	
	R45	270	red-violet-brown	Output Amp	C-3	
	R46	1	brown-black-gold	Output Amp	B-1/2	
	R47	1	brown-black-gold	Output Amp	A-1/2	
	R48	1K	brown-black-red	Output Amp	A-3	
	R49	1K	brown-black-red	Tx Led	K-5	
	R50	1K	brown-black-red	Rx Led	L-5	
	R51	10K	brown-black-orange	RF Rx Mute	D-7	
	P1	5K	502 or 53E trimmer	Mic preamp	F-10	
	P2	5K	502 or 53E trimmer	DSB gen / Rx mix	F-5	
	P3	10K	pot. w/shaft 10K	Audio Amp volume	L-8/9	
	P4	500	501 or 52Y trimmer	Amp linear	C-4	

Capacitors					
Checked	Ref.	Value	Ident./Comment	Circuit section	Located
	C1	100n	104 or 0.1	RX input	A-9
	C2	1n	102 or 0.001	Rx input	B-9
	C3	100n	104 or 0.1	Rx attenuator	C-10
	C4	82p	82P	Rx BPF	C-9
	C5	8p2	8P2	Rx BPF	C-8
	C6	82p	82P	Rx BPF	C-9
	C7	100n	104 or 0.1	DSB Gen/Rx Mix	E-7
	C8	10uF	10uf 25V or 35V (elec)	Mic preamp	E-10
	C9	100n	104 or 0.1	Mic preamp	E-10
	C10	330p	n33 or 331	Mic preamp	E-7
	C11	10uF	10uf 25V or 35V (elec)	Mic preamp	G-9
	C12	100n	104 or 0.1	Mic preamp	F-7
	C13	1uF	1uF 25V, 35V or 63V (elec)	DSB Gen/Rx Mix	G-6/7
	C14	100n	104 or 0.1	DSB Gen/Rx Mix	F-6
	C15	33p	33p or 33J	FI xtal filter	F-6/7
	C16	33p	33p or 33J	FI xtal filter	E-6
	C17	33p	33p or 33J	FI xtal filter	E-5
	C18	33p	33p or 33J	FI xtal filter	E-4
	C19	33p	33p or 33J	FI xtal filter	F/E-4
	C20	100n	104 or 0.1	SSB Dem/ Tx mix	F/E-3
	C21	220p	n22 or 221	DSB Gen/Rx Mix	H-6
	C22	220p	n22 or 221	SSB Dem/ Tx mix	H-5
	C23	100n	104 or 0.1	SSB Dem/ Tx mix	H-3
	C24	100n	104 or 0.1	SSB Dem/ Tx mix	G-5
	C25	100uF	100uF 25V or 35V (elec)	SSB Dem/ Tx mix	F-4
	C26	10n	103 or 0.01	SSB Dem/ Tx mix	H-4
	C27	100n	104 or 0.1	Audio Preamp	G-8
	C28	100n	104 or 0.1	Audio Preamp	G-8
	C29	10uF	10uf 25V or 35V (elec)	Audio Preamp	I-8
	C30	100uF	100uF 25V or 35V (elec)	Audio Preamp	H-10
	C31	560p	n56 or 561	Audio Preamp	G-9
	C32	100n	104 or 0.1	Audio Amp	I-9
	C33	10uF	10uf 25V or 35V (elec)	Audio Amp	I-9/10
	C34	100uF	100uF 25V or 35V (elec)	Audio Mute	L-7
	C35	100n	104 or 0.1	Audio Amp	K-8
	C36	100uF	100uF 25V or 35V (elec)	Audio Amp	K-10
	C37	10n	103 or 0.01	Audio Amp	K-9
	C38	10uF	10uf 25V or 35V (elec)	Audio Amp	J-10
	C39	220uF	220uf 25V or 35V (elec)	Power	H-7
	C40	100n	104 or 0.1	BFO	I-7/8
	C41	220p	n22 or 221	BFO	I-7/8
	C42	220p	n22 or 221	BFO	J-6
	C43	1n	102 or 0.001	BFO	I-7/8
	C44	100n	104 or 0.1	BFO	J-7
	C45	10uF	10uf 25V or 35V (elec)	BFO/VXO	K-7
	C46	100n	104 or 0.1	VXO	K-3
	C47	100p	101J	VXO	K-4
	C48	100p	101J	VXO	J-4
	C49	47p	47P or 47J	VXO	J-4
	C50	1n	102 or 0.001	VXO	H-3/4
	C51	100n	104 or 0.1	VXO	K-4
	C52	1n	102 or 0.001	Pre Driver	G-2/3
	C53	NO	not used	Pre Driver	I-1/2
	C54	100n	104 or 0.1	Pre Driver	C-5
	C55	100n	104 or 0.1	Pre Driver	F/G-1
	C56	82p	82P	Pre Driver	H-1
	C57	8p2	8P2	Pre Driver	G/F-2
	C58	82p	82P	Pre Driver	F-1
	C59	100n	104 or 0.1	Driver	E-3

Capacitors (continued)						
		C60	100n	104 or 0.1	Driver	E/F-2
		C61	1n	102 or 0.001	Driver	D-1
		C62	10n	103 or 0.01	Driver	C/D-2
		C63	10n	103 or 0.01	Driver	B-1
		C64	100n	104 or 0.1	Output Amp	D-4
		C65	100n	104 or 0.1	Output Amp	C-3
		C66	100n	104 or 0.1	Output Amp	E-2/3
		C67	100n	104 or 0.1	Output Amp	E-2/3
		C68	100n	104 or 0.1	Output Amp	B-2/3
		C69	10n	103 or 0.01	Output Amp	B-3
		C70	100n	104 or 0.1	Output Amp	B-4/3
		C71	100n	104 or 0.1	Output Amp	A-5
		C72	100n	104 or 0.1	Output Amp	C-5
		C73	10uf	10uf 25V or 35V (elec)	Output Amp	D-5
		C74	470p	470 Styroflex	LPF	A-6
		C75	1n	1000 Styroflex	LPF	B-6
		C76	470p	470 Styroflex	LPF	C-6
		C77	100n	104 or 0.1	PTT relay	G-5/6
		CV1	60p	Brown (Murata trimmer)	BFO adjust	J-5
		CV2	160p	Tuning Polyvaricon	tuning	L-2/3/4
		CV3	70p	Tuning Polyvaricon	tuning	L-2/3/4

Crystals						
Checked	Ref.	Frequency	Ident./Comment	Circuit section	Located	
	X1	4.915MHz		I.F.	E-6	
	X2	4.915MHz		I.F.	E-6	
	X3	4.915MHz		I.F.	E-5	
	X4	4.915MHz		I.F.	E-4	
	X5	4.915MHz		BFO	K-6	
	X6	12.031MHz or none		VXO	J-3	
	X7	12.031MHz or 12.096MHz		VXO	I-3	

Semiconductors						
Checked	Ref.	Type	Ident./Comment	Circuit section	Located	
		Transistors				
	Q1	BC547	BC547	Audio Mute	L-7	
	Q2	BC547	BC547	BFO	J-6/7	
	Q3	BC547	BC547	VXO	J-3/4	
	Q4	BC547	BC547	VXO	I-3/4	
	Q5	2N2222	2N2222	Pre Driver	I-1	
	Q6	BD135	BD135	Driver	C/D-1	
	Q7	2SC1969	C1969	Output Amp	A-2	
	Q8	BC547	BC547	RF Rx Mute	C-8	
		IC's				
	IC1	LM741	LM741CN or UA741	Mic preamp	F-8	
	IC2	SA/NE602	SA602AN or NE602AN	DSB gen/Rx mix	F-6/7	
	IC3	SA/NE602	SA602AN or NE602AN	SSB Dem/Tx mix	F-3	
	IC4	LM741	LM741CN or UA741	Audio Preamp	H/I-9	
	IC5	LM386	LM386N-1	Audio Amp	J-9	
	IC6	78L06	MC78L06	Dem/Gen supply	H-2	
	IC7	78L08	MC78L08	BFO/VXO supply	H-7	
	IC8	78L08	MC78L08	bias Driver	E-3/4	
	IC9	78L05	MC78L05	bias Output Amp	D-3/4	

Diodes					
	D1	1N4148	4148	Rx attenuator	B-10
	D2	1N4148	4148	RX ant. Limiter	A-9
	D3	1N4148	4148	Rx ant. Limiter	A-9
	D4	LED doble	bicolor	Rx-Tx	L-5
	D5	1N4001 or 1N4007	1N4001(7)	Audio Preamp	I-10
	D6	1N4001 or 1N4007	1N4001(7)	Output Amp	A-1
	D7	Zener 47V 1W	BZX85C47	Output Amp	A-3

Inductors/RF Transformers					
Checked	Ref.	Value/Type	Ident./Comment	Circuit section	Located
	L1	Axial 100uH	brown, black, brown	Rx attenuator	B-10
	L2	Axial 100uH	brown, black, brown	DSB gen/Rx mix	G/H-4
	L3	Axial 100uH	brown, black, brown	SSB Dem/Tx mix	G/H-3
	L4	Axial 39uH	orange, white, black	BFO	K-5
	L5	Axial 100uH	brown, black, brown	BFO	I-7
	L6	T68-2	Turns = see text	VXO	J/K-1/2
	L7	Axial 100uH	brown, black, brown	VXO	K-4
	L8	VK200	ferrite wound	Driver	D-3
	L9	Axial 100uH	brown, black, brown	Output Amp	B-3
	L10	VK200	ferrite wound	Output Amp	B/C-4
	L11	T37-2	Turns = see text	LPF	A-7
	L12	T37-2	Turns = see text	LPF	C-7
	T1	KANK3334 (5u3H)	K3334 or 5u3H	BPF Rx	B-9
	T2	KANK3334 (5u3H)	K3334 or 5u3H	BPF Rx	D-9
	T3	KANK3334 (5u3H)	K3334 or 5u3H	BPF Pre Driver	G-1
	T4	KANK3334 (5u3H)	K3334 or 5u3H	BPF Pre Driver	E-1
	T5	FT37-43	toroid 12t 3t see text	Driver	B/C-2
	T6	FT37-43	toroid10+10 see text	Output Amp	A/B-4

Note:

Parts written in **bold** are different depending on the ILER version you (ILER40 or 20). In the kit, you'll find all of these components together in a separate bag.

For ILER-40 are these.

120 QUADRANTS MAP

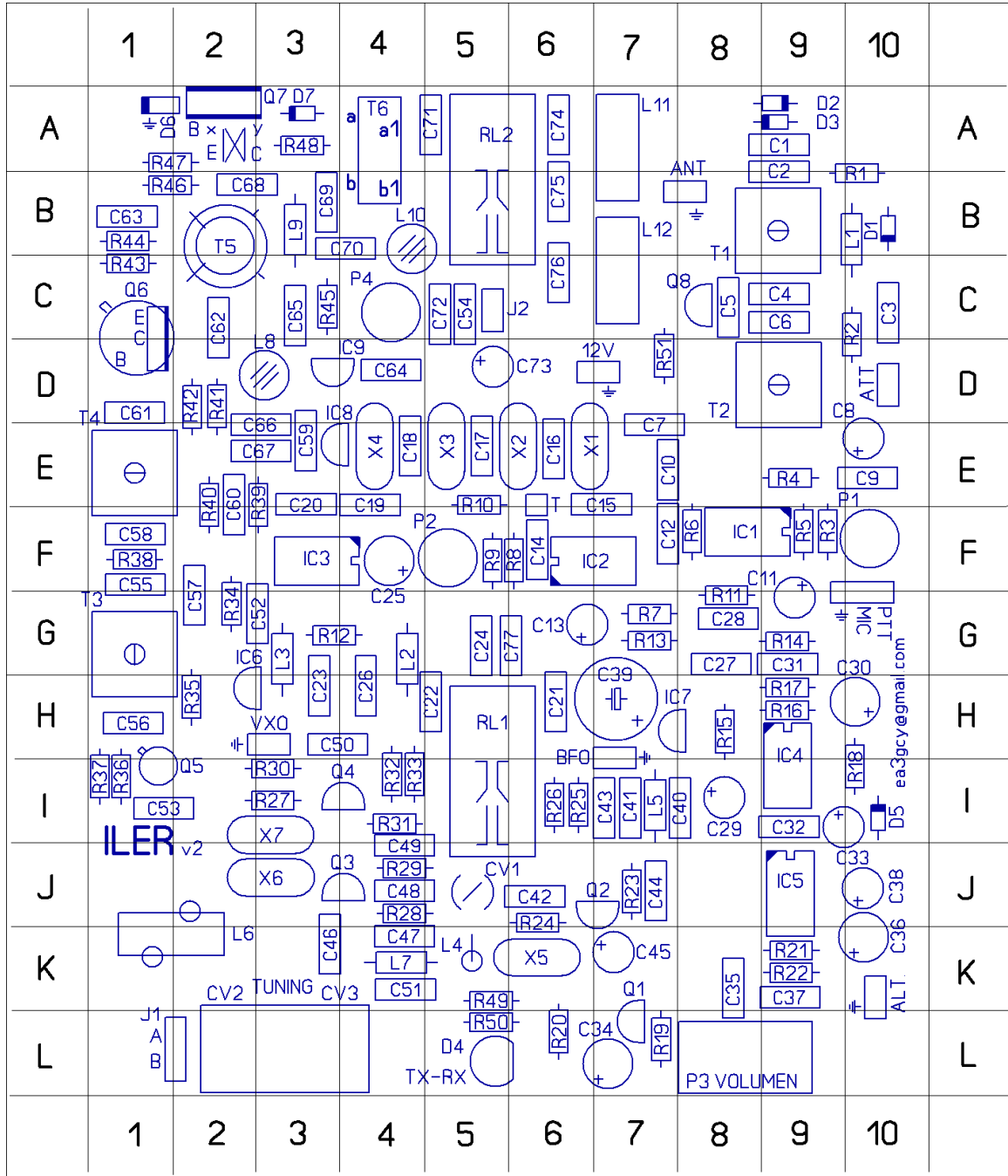

ASSEMBLY

You can use “individual component list” or “value/quantity component list”. The “value/quantity component list” is the quickest way to place components because all components of the PC board of the same value or type can be placed in a row. However, you need the “individual component list” to know how each component is identified and its location on the board. According to your personal experience may prefer to use the individual list, may find it is safer. I prefer this way.

The location of all components is very easy thanks to 120 quadrants map. After placing each component, you can mark it in the “checked column list”.

It is advisable that you inventory all parts to make sure everything is available and ready for assembly. Each builder may have his/her own way of organizing parts, but if you do not, you might try using a block of Styrofoam packing material. Parts are sorted by type and size (ohms, micro-farads etc).

RECOMMENDED ASSEMBLY SEQUENCE

□ Resistors

The resistors are installed first. Place all resistors R1 to R50 and the trimmers P1, P2 and P4.

P3 is the volume potentiometer DO NOT install now.

Refer to the parts list, and select the first resistor, R1. Bend its leads as close to the ends that will be possible, and fit them into the holes marked for them on the circuit board. Be careful that you do not confuse the resistors with the slightly larger axial inductors. All the resistors have a light straw coloured back ground body color with a gold band at once end.

When you have inserted the resistor’s leads into their holes, push the body of the component down onto the circuit board, and then bend the ends of the leads out slightly to hold the resistor in place. Then turn the PCB over and solder the leads to the printed circuit tracks. Make sure the resistor body flat against the board so that its leads are kept as short as possible. Please read the notes on soldering. Poor soldering is the most common cause of a kit failing to work first time, so please take the soldering advice to heart!

Cut the excess length of component lead off as close to the join as possible after you have solder it. Now fit the next resistor from the component list in a similar manner, and then carry on down the parts list until all the resistors are fitted.

Values which are in decade increments can also confused, such as 470, 4K7 and 47K. So, take a good look at the colors before you solder the part in place! If you doubt, use a multimeter to check the resistance value.

Note: R36 not used.

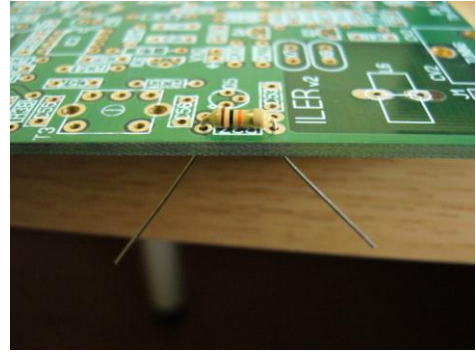
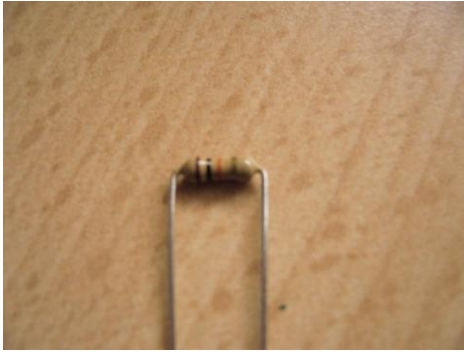

□ Axial inductors

L1, L2, L3, L4 L5, L7, L9

These components look just like fat resistors, but they have a blue or green background bodies. Inside the device is a small coil wound on ferrite material. Again refer to the component list to select the correct part for each position. Fit them to their designated places on the board in the similar way fitted the resistor, but about 1,5-2mm distance from the board.

Note: L4 mounted vertically

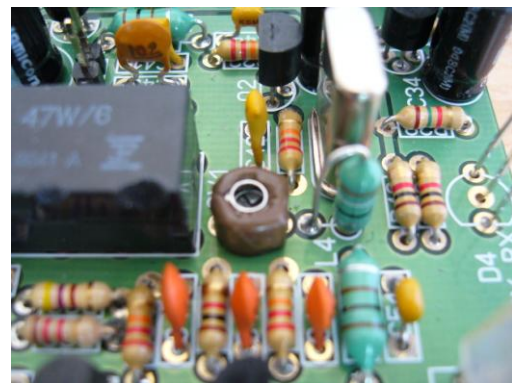
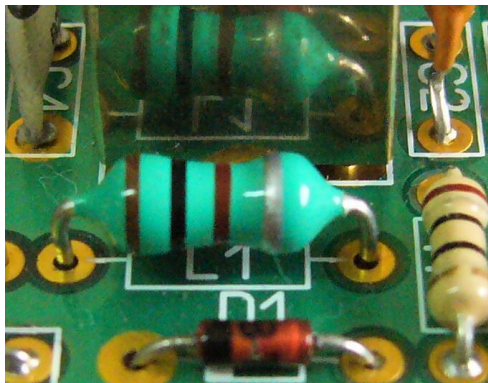

□ Diodes

Install the diodes next, take care to put these in the right way round. There is a band at one end of each diode's body this must match the drawing board.

D1, D2 and D3 are 1N4148, these are usually orange with a black band and has its type "4148" marked on it.

D7 This diode is similar to a 1N4148 but a little fatter. It is marked with BZX85C47

D5 and D6 are 1N4007 diodes these are black with grey band. Install D5.

DO NOT Install D6 bias limiter diode and D4 rx/tx bi-color Led

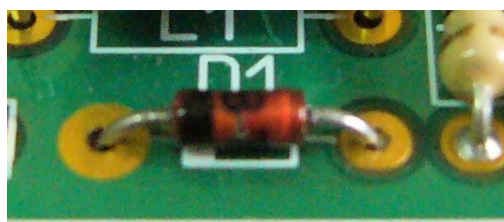

❑ Capacitors

There are Ceramic, Metallised Polyester, Styroflex and Electrolytic type capacitors. All these are your value printed on your body. Refer to the parts list “identified” column.

When fitting these, be sure to keep their leads as short as possible.

C74, C75 and C76 are styroflex capacitors, they are axial capacitors, but must be placed in vertical position. Values which are in decade increments can also be confused, such as 82p, 8p2. So, take a good look at the printed numbers before you solder the part in place!

Electrolytic capacitors must be fitted the right way round: the LONGER LEAD goes to the hole marked “+”, the other lead is “-” indicated by a band containing “-” signs on the side of the capacitor.

CV1 is a brown trimmer capacitor. Has no numbers printed. Place it round facing to the relay.

CV2 + CV3 are the same capacitor, they are a dual gang Polyvaricon tuning capacitor. DO NOT install now.

Note: C53 not used.

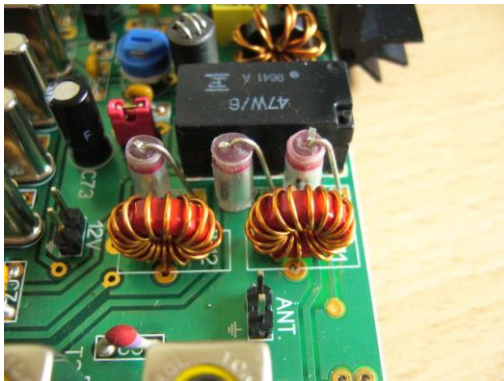

❑ Radial VK200 inductors

L8 and L10 are ferrite radial wideband RF chokes. They must be installed vertically.



❑ Terminals pins

Place and solder the “Mic”(3)(G-10), “12V”(2)(D-6/7), “ATT”(2)(D-10), “ANT”(2)(B-8), “ALT”(2)(K-10), “D6”(2)(A-1), “VXO”(2)(H-3), “BFO”(2)(I-7), “J1”(3)(L-1/2), “J2”(2)(C-5) “T”(1)(E/F-6) terminal pins.

Place jumpers on “J2” and “J1-B” pins.

Turn over the board with one hand and tighten the terminals with a female while soldering, and will not burn your fingers. With the other hand please use the solder to weld the plate closer to the tin wire. If you have someone to help, much better !

❑ Transistors

These all have their type numbers marked on them. Insert them into PC board the right way round as the outline printed on the board indicates. Fit Q5 about 1-2mm distance from the board. Place Q6 with the letter printed facing outside of the board.

DO NOT install Q7 (power amp) now.

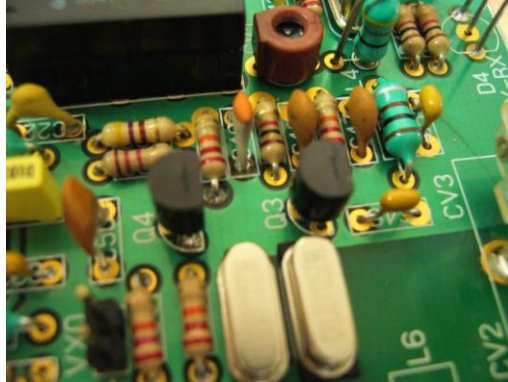

❑ Integrated Circuits

The outline on the board for the ICs has a “U” notch on one end. This indicates the pin 1 end of the IC. There is also a notch on one end of the sockets. This end goes over the “U” notch outline on the board. Finally, pin 1 of the IC’s is marked with a round dimple or dot. This end of IC will go towards the notch on the socket or “U” on the outline.

Install the IC1, IC2, IC3, IC4 and IC5 sockets in your places printed on the board. Make sure the socket’s body is flat against the board.

Next, insert IC1, IC2, IC3, IC4 and IC5 in your sockets.

IMPORTANT: Make sure that ICs are perfectly placed deep in its socket, if it can cause malfunction.

Now, install IC6, IC7, IC8 and IC9 insert into PC board the right way round as the outline printed on the board indicates, they are supply regulators.

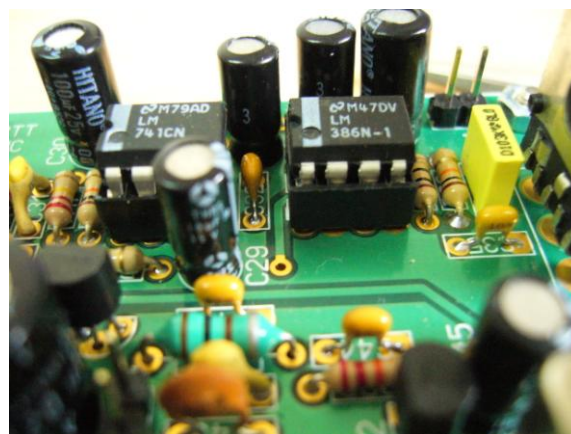

❑ Crystals

Install X1 to X7.

X1, X2, X3 and X4 are the SSB FI filter, X5 is the BFO oscillator crystal, these crystals are matched (have handwritten numbers on its body) and have the same resonance frequency, thus obtaining the best quality of the filter. X6 & X7 duet are the VXO oscillator crystals.

For the housing of the crystals does not touch the board pads, must separate a little from board. Place them about 0,5-1mm distance of board.

You must stretch the X6 and X7 legs carefully to insert them in your place, have an insulating sheet and there is no objection to touch the pcb.

If you chose the 12.096MHz option, only used a single VXO crystal and can place it in X7.



❑ Relays

Install RL1 and RL2 relays will only fit one way round.

Make sure the relay's body is flat against the board.



❑ Toko shielded coils

T1, T2, T3 and T4 are "KANK3334" or "5u3" compatible Toko coils. RF transformers to bandpass filters. Make sure his body is flat against the board.

You may need more time to heating and soldering the shielded tabs.

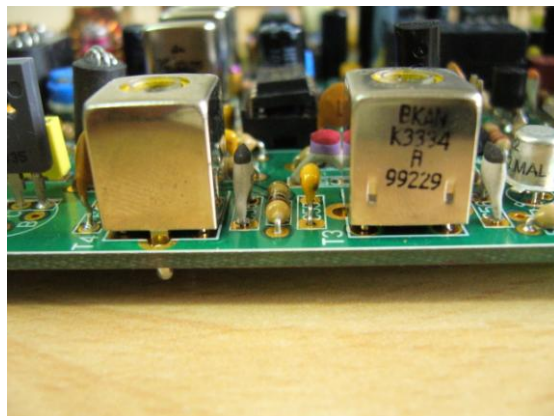

□ L11 and L12 LPF Toroids

L11 and L12 are identical. Is used the T37-2 (9,5mm/0,375in diameter red toroids).

Take 25cm (10") of the 0,5mm diameter enameled copper wire, and wind sixteen (16) turns on the red T37-2 toroid core. Space the turns evenly around the core, and wind the wire tightly so that it follows the contours of the core, without any air gaps between the wire and the toroid. Turns must be uniformly distributed around the circumference of the toroid. Leave ends leads about 10-20mm (0,70"). Scrape the area of the wire to be soldered using a sharp hobby knife.

The nominal L11 and L12 value is 1.02uH.

Counting the turns: if the wire passes through the toroid center hole, it counts as a turn.

Important: Wind the toroid exactly as shown in the pictures

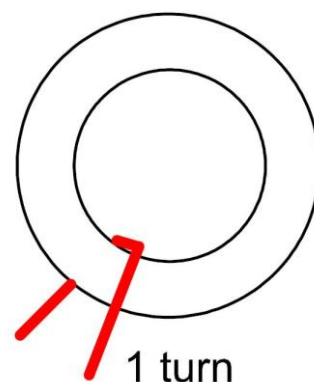
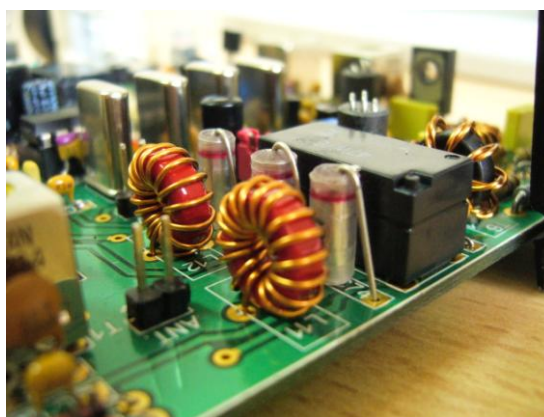
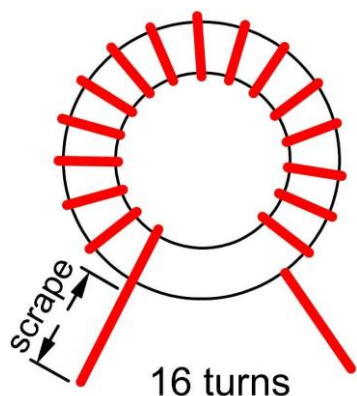

□ T5 Toroid Transformer

T5 is a impedance matching transformer. Is used a FT37-43 (9,5mm/0,375in diameter black toroid). It has 10 turns primary and 3 turns secondary windings.

- Take 17-18cm (7,5") of the 0,5mm diameter enameled copper wire, and wind ten (10) turns on the black FT37-43 toroid core. - Space the turns around the core, and wind the wire tightly so that it follows the contours of the core, without any air gaps between the wire and the toroid. Turns must be uniformly distributed around the circumference of the toroid. Leave ends leads about 10-20mm (0,70").

- Now, take 8-9cm (3,5") of the 0,5mm diameter enameled copper wire, and wind three (3) turns on the other side of toroid, space the turns between the before winding. Leave ends leads about 10-20mm (0,70").

- Use a sharp knife, paper cutter or similar to scrape the insulation off the coil's end leads before inserting them into their PCB holes and soldering them to their tracks. Place it at about 1mm in height on the board.

- The 3 turns winding goes to the output transistor Q7 and the 10 turns winding goes to the Q6-C62.

The nominal values of inductance are 3.15uH for 3 turns winding and 35uH for 10 turns.

Counting the turns: if the wire passes through the toroid center hole, it counts as a turn.

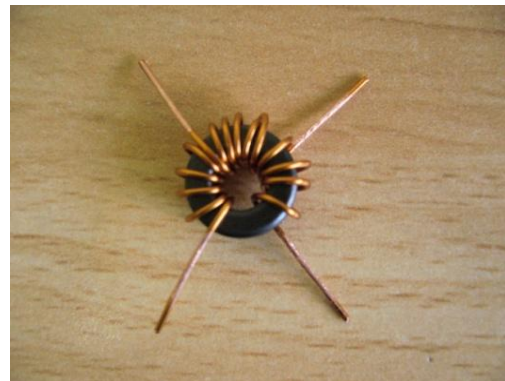
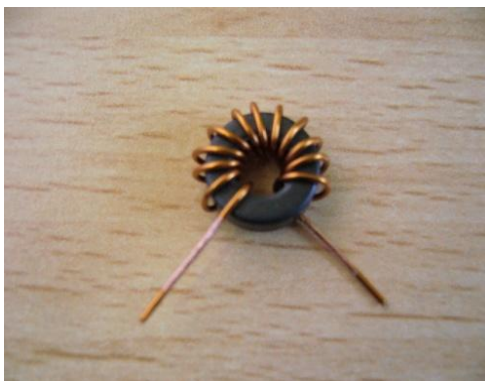
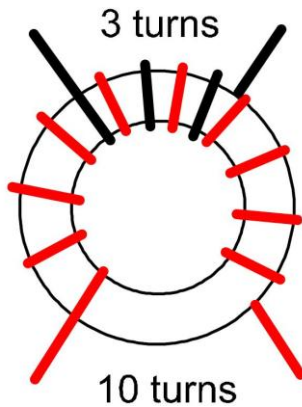

Important: Wind the toroid exactly as shown in the pictures. You must respect both the number of turns as the winding direction.

□ T6 Toroid transformer

T6 is a bi filler wound impedance matching transformer. Is used a FT37-43 (9,5mm/0,375in diameter black toroid). It has 8+8 turns.

- Cut the wire. You will need 31-32cm (12in) of 0,5mm diameter enameled wire.

- Bend the wire in half.

-Twist so there are about two or three twists per centimeter or four to five twists per inch.



16cm (32cm wire bend in half and shown)

-Leave about 10-15mm (1/2") of wire, measured from the start of the wire to edge of the core, at the start of this step. Now wind eight (8) turns onto the core. A turn is counted each time the twisted wire passes through the centre of the toroid core.



-Spread the turns out around the entire toroid core.



- Cut the bent end to separate the two windings.
- Scrape the area of the wire to be soldered using a sharp hobby knife. The ends of the coils made here will all require this preparation prior to insertion and soldering in the PCB.
- Using the ohms or continuity test range of your multimeter, work out which ends are which. Identify "a", "a1", "b" and "b1" ends.
- Install the toroid in the holes marked on PCB

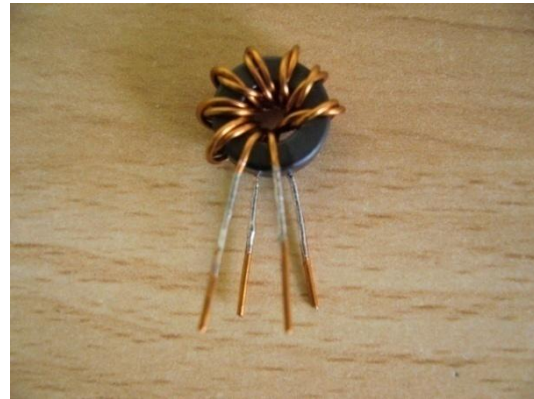
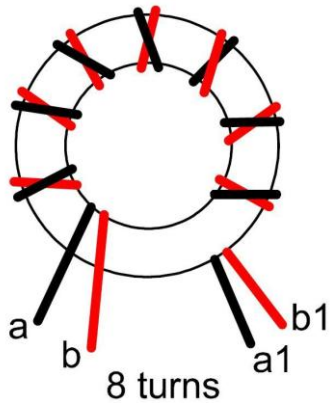

Note: For more clarity in the picture there is a red and black wire. In reality the two wires are the same color.

□ CV2/CV3 Tuning Polyvaricon VXO

Fit the hardware shaft to polyvaricon. If you think necessary, you can use a small dab (only one) of glue fixing screw (be extremely careful that the glue does not enter into the polyvaricon through the base of the shaft!). Place the Polyvaricon at about 3-5mm in height on the board (see picture). This allows you to be adapted to front box. Please, do not solder until you see how it is mounted in your box.

You may want to mount the polyvaricon outside of the board. Is a good idea, no objection to wire them, but use short and rigid wires. ¡ Any movement will change the tuning !

This polyvaricon contain two variable tuning capacitors inside. J1 select which gang used, place “B” jumper to choose CV2, the higher value capacitor, “A” jumper to choose CV3, the lower value capacitor.

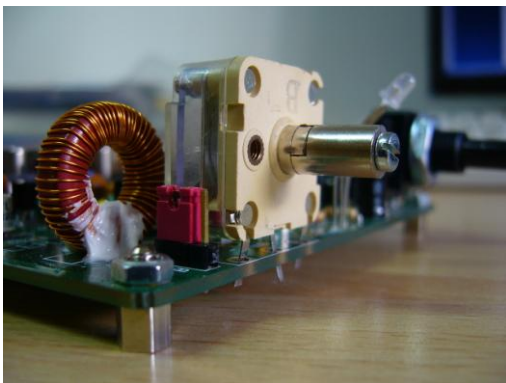

CV2 is about 160pF, CV3 is about 70pf.

In the back there are two fine tuning trimmers. The below is for CV2 (J1-B) and above is for CV3 (J1-A).

These adjustments affect 10-20KHz until the upper limit of the coverage! Make the adjustment with polyvaricon in lowest capacity (the maximum in the clockwise direction)

IMPORTANT: When screwing polyvaricon to front of the box (M2,5 x 5 screws) to be very careful that the screws do not block the internal mechanism of polyvaricon. If necessary, you should add some washers to prevent it.

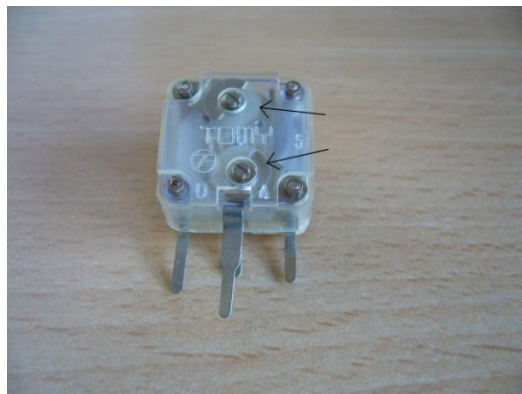

□ L6 Vxo Tuning inductor

Is used a T68-2 (18mm/0,690in diam. red toroid).

Take about 113cm (44,4in) of the 0,3mm diam. enameled copper wire, and wind fifty four (54) turns on the T68-2 toroid core for 12.031MHz crystals or fifty five (55) if you use 12.096MHz crystal. Leave the ends of the wire long (1,5-2cms)

IMPORTANT!: DO NOT PLACE the L6 now. Will make after, in the final adjustment section (see the “testing and alignment” section).



L6 can be wound in two stages. Spend half of the wire through the toroid, wind around the half of the toroid, then, rotate the toroid and wind to complete the other half. If you are unsure of how many turns given. With a magnifying glass and focus can easily count.

□ P3 Volume Potentiometer and D4 Tx-Rx LED

Install the P3 volume potentiometer and D4 double LED as shown in the picture.

You may want to mount the separate elements of the board. No problem in wiring. Attach them with small cables.

Some shipments are made with bi-color LED terminals backwards. This happens with the LED that is included in this kit. The LED should light up in red on TX and green on RX, if not, simply turn to the LED (center leg is always the GND).

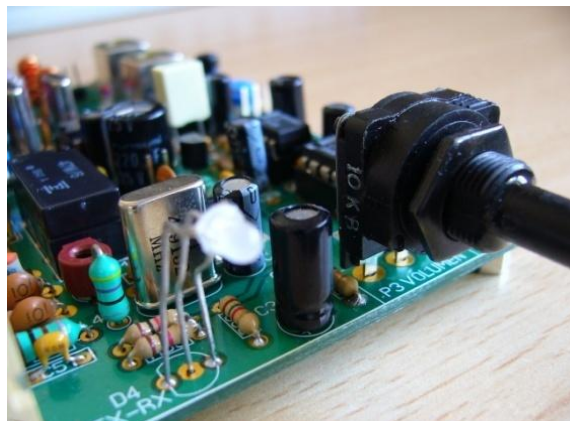

□ “E–C–x–y” bridges and Q7, D6 installation

“E-x-C-y” bridges combination allow different transistor types used in Q7. We may use transistors that have their legs placed differently (see Annex).

This ILER-20 kit use Q7 2SC1969 and you **MUST FIT** the “E-y” and “C-x” bridges.

Cut small pieces of electric wire to join "E" with "y" and "C" with "x"
Be careful that no wires are touching each other.

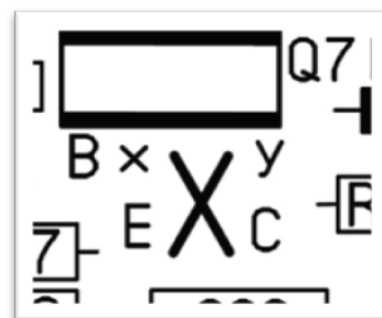

The Q7 encapsulation must be electrically isolated from the radiator. Use talked washer and mica sheet that came with the transistor. Once clamped transistor, check with a multimeter that the transistor housing does not contact the screw or the radiator. Use the insulators supplied with a screw and a nut M3. It is advisable to apply some thermal paste.

Install the diode D6 touching to Q7 and heatsink with some thermal paste. **The cathode (marked by a white band on the diode) goes to the pin marked GND symbol on the board.** This diode helps to stabilize the current "bias" when the transistor is heated.

You can make a hole in another part of heatsink to tailor your position to your particular installation.

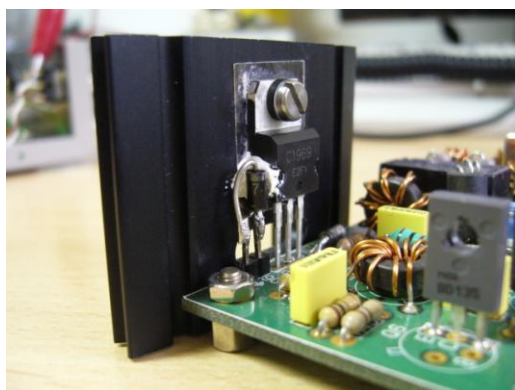

DO NOT operate the transceiver without a heatsink for Q7.

□ "ATT" Terminals to enable the RX attenuator

In the terminals "ATT" you can connect a simple switch to activate the receive attenuator. The amount of attenuation is inversely to the value of resistor R1 which derives a part of the signal from the antenna to ground. When you use the Iler-40 may want to set a different attenuation level, simply replace the R1 with a value above or below.

The receiver can operate perfectly without using the terminals "ATT", but should receive very strong signals may not reduce the signal input of the antenna and may cause IC2 intermodulation.

If you work regularly with ILER-40 at different times of day and night can be very useful to add a "RF Gain" potentiometer, which you can adjust the RX input attenuator as more convenient in every situation (see Annex 5).

□ "T" Carrier generate terminal

The terminal marked "T" is located in quadrant E/F-6.

This terminal is provided for generate a carrier for test functions, antenna, settings couplers etc.

Connecting terminal "T" to GND becomes unbalanced transmission modulator and a carrier is generated. After the adjustment, do not let any cable hanging from the terminal "T".

TESTING AND ALIGNMENT

☐ First Testing

- Adjust P2, (carrier suppression), P3 (volume pot) and P4 (bias adjust) to mid position.
- Adjust P1 (mike gain) to minimum position. (Counterclockwise)
- Connect a speaker or headphone in "ALT" pins on the board

IMPORTANT: Use a good quality speaker box. A poor speaker cast on the ground all the work of the transceiver.

- If you use headphones set the volume low, this receiver does not have AGC. An unexpected loud noise can damage your ears !

- DO NOT connect any MIC.
- Turn on the power supply (12-14V) to the "12V" pins on the board.
- Measure the basic RX voltage points:

Rx-Tx LED shining green (if placed). If glows red, turn it.

8V at the leads L5 and L7

6V at the leads L2 and L3

- Move the volume a maximum, you should hear a smooth background noise.

If all is OK, you can continue.

If something is not right should be checked it. (see "If your Kit does not work after final assembly")

☐ L6 VXO Tuning inductor & CV3/CV3 Polyvaricon adjustment

The next job is often more entertaining than you expect. Is not plug & play. Find a time that does not hurry, take it easy and enjoy!

Solder the L6 wires in place. Leave the ends of the wire a little long to allow separate or merge the turns.

Connect the frequency counter to the "VXO" terminals. If the input of your frequency counter is of low impedance, insert a resistor of 470 ohms minimum or small capacitor (try 22pf or less) between the frequency counter probe and the terminals to reduce the interaction with the VXO oscillator.

If you do not have frequency counter you can use a good quality SSB or CW receiver that covers the frequency of the VXO about 12.000Mhz and has accurate digital readout. Connect to the antenna input of a piece of wire make a loop and place it near the VXO.

Note: It is recommended to have a frequency counter for this setting, do it with a receiver is very uncomfortable.

The IF frequency 4.915MHz is subtracted to the VXO ex. 12.010MHz for the working frequency 7.095MHz (X6-X7 option = 12.031MHz). Another example would be FI 4915MHz and VXO 12.065MHz = 7.150MHz (X6 option = 12.096MHz).

Spacing or together the turns, changes the coverage. The turns together, increases the inductance and therefore larger coverage. If you separate the turns the inductance and coverage decreases.

Spreading or approaching a little the turns, are achieved of few Khz changes.

This polyvaricon contain two variable tuning capacitors inside. J1 select which gang used. Place "B" jumper to choose the higher capacitor CV2 (160pf), place "A" jumper to choose the lower capacitor CV3 (70pf). You can also use the two capacitors in parallel.

See the table below:

	J1-B (CV2)	J1-A (CV3)	
	Cover.	Cover.	Induc. Aprox.
Closely Turns	90KHz	70KHz	17,5uH
Turns close together	65KHz	45KHz	16uH
Turns spaced	40KHz	25KHz	14,5uH

Values to guide. Influenced by the turns of L6, the back fine tuning trimmers and the components tolerances.



In the back of polyvaricon there are two fine tuning trimmers (padders). The below is for CV2 (J1-B) and above is for CV3 (J1-A). **These adjustments affect 10-20KHz the upper limit of the coverage!** Make the adjustment with polyvaricon in lowest capacity (the maximum in the clockwise direction)

In the case that even with spaced turns the coverage is too large or together at maximum is very small, you can remove or add one turn of L6.

When you are sure VXO coverage you want, L6 should fixed in place on the board. I suggest two alternatives:

-Use a bit of wax or termofusivel glue stick (not containing water) to secure it in place. In the end, you can also use nail polish to seal the turns.

Caution: some adhesives, due to its composition, can dramatically affect the characteristics of the L6 even after the product has dried. That is, once fixed the inductance L6, VXO frequency can change considerably in relation to before adjustments.

-The best alternative, very efficient and cleaner will use a small plastic retaining clamp through holes made in the board as shown in the picture.

Once down the clamp, the turns can move slightly and make a slight adjustment before sealing with little nail polish or similar.

This is important because the vibrations change the VXO frequency and would cause the received and transmitted signals to be heard "trembling".

IMPORTANT: Before attaching L6 definitely on the board, make all the transceiver tests and make sure that the coverage is that you want.

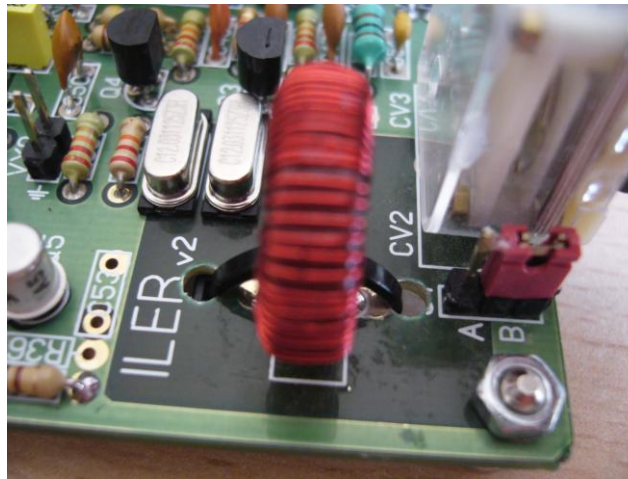

I recommend you this L6 turns and type. It works very well! However the VXO inductor can be modified and experienced for other coverage. Higher inductance will increase the coverage but decreases the stability and may not work or vice versa.

For good stability I recommend a maximum coverage of 60-70KHz.

Also with a large coverage the tune will be very uncomfortable and need to add a fine control, a mechanical reduction gear or an "fine tune control" means second variable capacitor or varicap diode (see Annex 4). If you have graphic skills, you can draw a dial on the front panel with the frequency scale that will serve as a guide.

Do not worry if you can not exactly set a margin to the "Khz". So important is that they are 50, 49 or 51Khz?

To put this in other segments of the band very different from those projected here, you should use the other nominal VXO frequencies crystals.

□ BFO/Carrier Oscillator

There are two ways to adjust the BFO Oscillator frequency

- Rough alignment:

Turn on the power. Let the rig warm up about 5 minutes.

May be made by adjusting CV1 while listening to a received LSB signal on 40 meters. This is a two-handed operation as you have tuning the VXO frequency for best intelligibility while searching for the best quality audio with CV1. Repeat the settings until you get the best result.

- Instrument alignment (you need frequency counter):

Turn on the power. Let the rig warm up about 5 minutes. Connect the frequency counter to the "BFO" terminals. If the input of your frequency counter is of low impedance, insert a resistor (470 ohms or more), or small capacitor (try 22pf or less) between the frequency counter probe and the terminals to reduce the interaction with the BFO oscillator.

Adjust CV1 until the frequency is around 4.913.5MHz. If the voice sounds a little too much like "Donald Duck", re-adjust CV1 slightly and re-tune the receiver.

CV1/BFO total coverage is about from 4.912.8 to 4.914.5Mhz. The capacitance of the trimmer goes from maximum to minimum in 1/2 turn (180 degrees). If you look inside the adjustment hole, you will see what looks like an arrow point on one end of the screw slot. When this points to the flat edge of the trimmer, the capacitance is at minimum.

Note: BFO adjustment is important for the reception, but also affects significantly in the quality modulation transmission. You can make your signal is heard too sharp and metallic or very bass and dull.

□ T1 and T2 RX bandpass adjust

Note: You need for this adjustment tool "trimming" suitable for this type of coils. If you use a regular screwdriver, you risk breaking the core of the coil.

Connect an antenna to the receiver. Set T1 and T2 alternately to get the most noise in the speaker. Now, try to tune a stable signal within the band and re-adjust T1 and T2 until you hear it with the highest possible level.

If you have an RF generator, start by injecting a signal within the reception segment about 1uV and tune. Reduce to the minimum level that is audible and adjust T1 and T2 alternately to get the best reception level.

Once you have completed all adjustments and ILER-40 verification, may make a slight re-adjustment of the reception if desired.

REMEMBER: All transmission tests should be done with a 50ohms load or antenna connected on output transmitter.

DO NOT operate the transceiver without a heatsink for Q7.

□ TX Output Amp bias adjust

IMPORTANT: Make this adjustment "in cold".

Remove IC3 from its socket. Adjust P1 (Mic. gain) to minimum (anti-clockwise direction). Remove the J2 jumper. Adjust P4 ("bias" adjust) in half of its position or near.

Connect a current meter in the 200mA range in series with the pins of J2.

Keyed PTT Mic. or join the PTT terminal to GND, set P4 to measure about 40-45mA. When the Q7 transistor warms, this value increases, this is normal.

If you do not milliamp meter, you can be adjusted P4 about to 75% of its travel.

Once finish the adjust, re-insert J2 jumper and IC3. Re-adjust P1 (Mic. Gain).

□ T3 and T4 TX bandpass adjust

Note: You need for this adjustment tool "trimming" suitable for this type of coils. If you use a regular screwdriver, you risk breaking the core of the coil.

Connect a 50 ohm load and a power meter at the antenna jack.

I propose two alternatives for setting the transmission passband:

-If you have an audio generator, inject a signal of about 20mV 800-1000Hz to "MIC" input. Put to TX the transmitter (key PTT) and adjust T3 and T4 alternately to achieve maximum power reading on the meter.

-If you have no instrument, connect the "T" terminal with a cable to any ground point (GND) of the pcb. This will cause the modulator to generate a carrier. Key the PTT and adjust alternately T3 and T4 until the maximum power level on the meter.

Once you have completed all adjustments and ILER-40 verification, may make a slight re-adjustment of TX bandpass if desired.

□ Balance modulator adjust

Remove IC1 from its socket. Adjust the MIC gain P1 to minimum. Adjust P2 in its middle position.

Turn on the power. Let the rig warm up about 5 minutes.

Now, keyed the PTT mic and monitors the transmit output with an oscilloscope (with a 50 ohms. load connected to the antenna output). Adjust P2 for the lowest possible output signal.

If you do not have an oscilloscope, you can hear the transmitter signal in SSB/CW receiver, set up to hear the slightest carrier signal. Note that a receiver as close, ALWAYS hear a weak residual signal.

IMPORTANT: The mic input Iler-40 has a very good gain and offers a very convenient operation and a good quality modulation. It is best to use a dynamic microphone classic, for example one of CB.

To use electret microphones must make a small change in the circuit (see Annex 6).

I recommend dynamic microphones.

It is not advisable to use amplified microphones.

As with the speaker, be careful with the type of microphone gain setting, an inappropriate microphone or excessive gain, can "pull on the ground" the quality of transmission.

□ Gain microphone P1 adjust

Adjustment without instruments.

Connect a 50 ohm load and the power meter to antenna jack. Adjust P1 (Mic gain) in its middle position.

Plug the microphone to MIC input (J3), push PTT to go TX.

Connect a scope to antenna output, set the oscilloscope to display the signal envelope. Speaking in front of the microphone, set P1 at the point before displayed signal distortion.

If you have no instruments, talk or whistle in front of the microphone. Adjust P1 so as to obtain the maximum level on the meter. The P1 must be set right at the point where maximum power is obtained or a little earlier.

There is no doubt that this adjustment will be a little ambiguous as it depends on the type of voice and speech of the operator. Use the system of "trial and correction."

Note that:

-An excessive mic gain saturate the modulator and cause the generation of spurious signals.

-Excessive gain will be heard with distorted modulation.

It is recommended that ask controls modulation to a trusted friend.

ANNEXES

Annex 1. Loudspeaker "ALT" terminals

In the terminals "ALT" will connect the loudspeaker. Please, use a good speaker box, a bad one, can degrade the final result of a good receiver.

If you use the Iler-40 as a base transceiver may have a more powerful sound level using a powered speaker for PC multimedia type.

Annex 2. TX Output Amp. Q7 Transistor.

Transistors 2SC1969 supplied with this kit is a good output transistor HF/CB and have been selected and tested to work with ILER kits.

If necessary you can use a substitute. Other CB transistors as 2SC2166, 2SC1945 etc. might be appropriate and offer similar functionality. But each have different pinout and bias adjust (R45 value).

You can modify the value of R45 for the adjustment range of the quiescent current of "BIAS" with P4 is correct. "E-x-C-y" bridges combination on the board allow different transistor types used in Q7.

Annex 3 Added to VXO.

Why use a VXO?

The classic and cheaper alternative to VFO or VXO is a simple VCO.

For the result of the heterodyning mixtures in RX and TX especially, is as clean as possible, is advisable to use an OL above the IF and above the working frequency.

In our case, the IF is 4.915Mhz and the frequency is 7.000Mhz. A VFO 2.185Mhz of 2,085 would be easy and stable, but the cleanliness of the signals produced in the mixer would be far from those obtained in the ILER-40 through the use of a VXO of 12Mhz.

The low level of spurious signals that are obtained in the Iler-40 by the use of LO 12Mhz. would hardly achievable with a VFO and a circuit of similar complexity.

Alternatives to an LO would be a suitable PLL controlled VCO, although its cost and circuitry would occupy much of the Iler-40 or a DDS, while the DDS also have a remarkable level of spurious and need a microcontroller.

The ILER-40 was designed to work within a small segment of the band around the QRP frequency, which is 7.090Mhz. However, you may want to increase the coverage of tune. Here are ideas on how to tune more comfortable if they increase the coverage of VXO (see "L6 VXO Tuning inductor & CV2/CV3 Polyvaricon adjustment")

Again, remember, before making any additions or modifications build and test the operation of the kit as shown in the general instructions. If you are going to experiment with tuning, we strongly recommend you first check the operation of the VXO and around the complete transceiver as originally described.

ea3gcy not responsible for problems caused by modifications of the original circuits.

Annex 3.1 Add a "Fine Tuning" to VXO.

The tuning of the VXO polyvaricon has a half a turn travel. When coverage is over 35-40kHz. the tuning will be very uncomfortable. The Iler-40 was designed to work around the 7.085Mhz QRP frequency (for example 7065 to 7.100Mhz). Modifying VXO coil (L6) can cover near 100Khz (with less stability), but this will need to add fine tuning. It may be through a reduction gear or a second polyvaricon or varactor (see the pictures of both below).

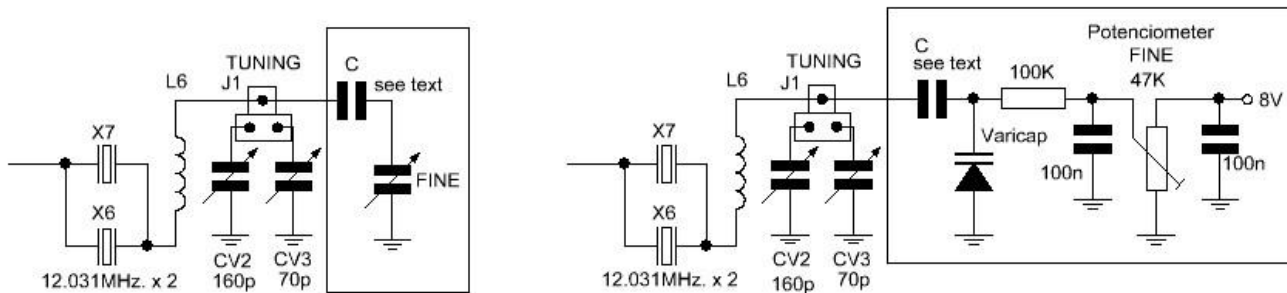

The "C" value limited action of varicap or polyvaricon. Start with a small value of about 10pf and increases proportionally to obtain the range of "fine tuning" required. Everything depends on the capacity value of the variable capacitor or varactor disposal. This is an experimental work "trial and correction". Note that the effect of fine tuning will be noticeably different in either end of the main tuning polyvaricon, this is because when the polyvaricon is at its maximum capacity it is less affected from external capacity is added, however in its position of minimum capacity, the opposite occurs. Remember: to make the auxiliary wiring VXO rigid cables must be used, as short as possible and close to the board. Any movement or vibration affect the tuning.

If you have no experience in RF testing, we recommend that you seek expert help from ham, if it deems necessary please contact: ea3gcy@lleida.org orea3gcy@gmail.com
IMPORTANT: If you are going to experiment with fine tuning, we strongly recommend that you first check the operation of the VXO as supplied.

Annex 3.1 Add segments to VXO.

Probably the most basic and inexpensive way widen the coverage VXO maintaining tune comfortable is add fixed capacitors in parallel with the tuning polyvaricon.

To do this we must adjust and configure the VXO to a rather moderate range (about 35-40Khz or less) as explained in "L6 VXO Tuning inductor & CV2/CV3 Polyvaricon adjustment". Once the VXO working correctly, just have to add a capacitor in parallel with the polyvaricon and select with a switch, as shown in diagram (capacitor values are approximate).

By adding capacitors to the variable main capacitor "polyvaricon", low frequency coverage while the range decreases significantly. This happens because as we add more external fixed capacity, has less effect the polyvaricon. In this case I recommend adding just one or two segments apart from the normal. See the following table what happens in a real example:

	Seg.	from	to	Cover	Band
Polyvaricon (jump.J1A)	1	11.973MHz.	12.015MHz.	42KHz.	7.058 a 7.100MHz.
Polyvaricon (jump.J1A) + 47p	2	11.961MHz.	11.979MHz.	18KHz.	7.046 a 7.064MHz.
Polyvaricon (jump.J1A) + 100p	3	11.952MHz.	11.961MHz.	9KHz.	7.037 a 7.046MHz.

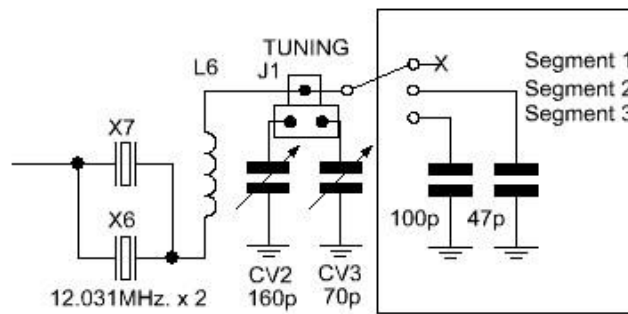

The capacitors must be of good quality such as "NPO" "Styroflex" or similar to avoid adversely affected the stability of the VXO.

Note that when switching from one segment to another superior, the tune suddenly jumps and for example, if we are at the upper end of a segment, we meet at the upper end of the segment to which we have changed, so that to keep tuning "more or less" from where we were, we should move completely to the lower end line and go from there.

If you have graphic skills, you can draw a dial on the front panel with the three frequency scales that serve as a guide.

Note: Once again, we must stress that to make the switch and capacitors wired to use rigid cables, as short as possible and close to the board. For example, solder capacitors directly to the GND of the board and their other ends to the switch and from this, a solid cable and short to polyvaricon (a miniature switch may be appropriate). Any movement or vibration affect the tuning.

IMPORTANT: If you are going to add segments to the VXO, we strongly recommend that you first check the operation of the VXO as it is originally supplied.

Annex 4. Adding "RF Gain" potentiometer".

The ATT switch terminals active a fixed level of attenuation and sometimes can be not the most suitable for the band conditions.

If you work regularly with ILER-40 at different times of day and night can be very useful to add a "RF Gain" potentiometer, which you can adjust the RX input attenuator as more convenient in every situation. This will help to minimize the undesirable effects of saturation at "broadcasting" stations close to the band that could keep you working comfortably in 40M.

Place a 1K linear potentiometer as shown in the following picture. Try to place the potentiometer as close as possible to the PCB and use short cables. Also you can use thin coaxial cable.

You can place the pot on the back panel of the box.

- Remove the C1 and R1 and perform the wiring plate as shown in the drawing.

(The fixed attenuator ATT terminals not be used)

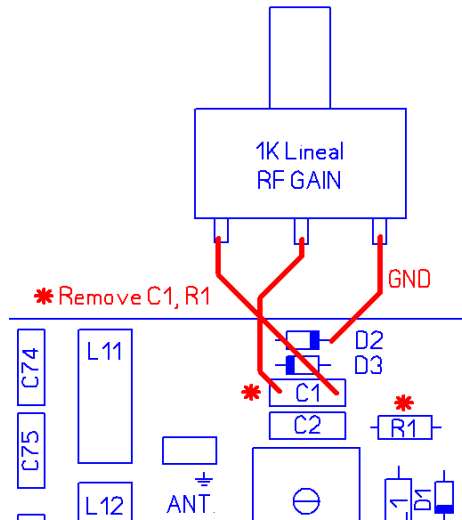

Annex 5. Using a microphone "electret".

Today, they are common and very cheap “electrets” microphone capsules, if you want to use a mic with ILER-40, simply make a few simple modifications in order to reduce the preamp gain IC1 and power the electret microphone capsule.

- Replace the existing R6 for a 22K.
- Connect 1K resistor between the leg 3 of IC1 (power) and the input terminal of "MIC" (below the board)

Note: The common electret microphones pick up sound from the environment in the intervals of voice, and because of its high sensitivity often cause some voice compression. In my opinion, a dynamic mic usually work better in SSB.

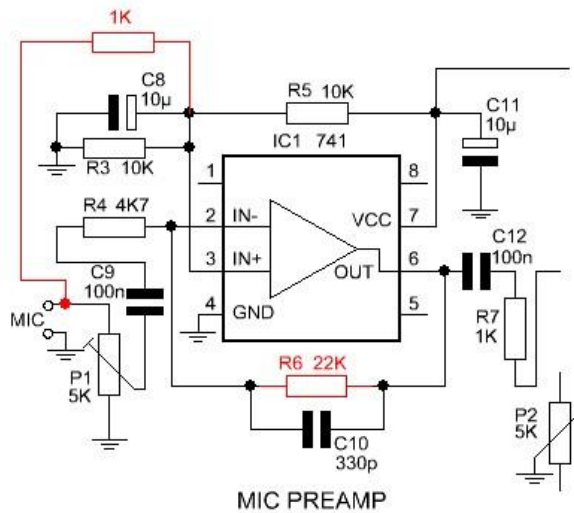

IF YOUR KIT DOES NOT WORK AFTER FINAL ASSEMBLY

Do not worry, it is not uncommon for a building does not work "the first", take it calmly, they are small bugs that will be easily remedied.

Most faults are due to poor soldered connections or components misplaced; it is very rare to be supplied with a faulty component.

Before taking measurements with instruments, check all connections, check carefully that there is a defective weld, shorts between tracks, sockets not making good contact or component placed in the wrong place.

If your kit does not work after final assembly, please follow these three steps in order:

- Double-check EVERY step in the assembly manual, soldered joints, short circuits or incorrectly fitted components.
- Ask an experienced ham or hobbyist friend to review your work. A fresh set of eyes can catch a detail which you may have overlooked.
- You are welcome to ask for technical assistance to ea3gcy@gmail.com

If necessary, you can send me the kit for review, however, I will apply a fee for work undertaken, will try to be as moderate as possible.

Should fault finding be necessary, a table of voltages is given below, IC's and transistor voltages were measured both in transmit (no modulation, P1 to minimum) and receive. If there is a failure, any value can be very different.

IC Ref.	Type	pin1 Rx	pin1 Tx	pin2 Rx	pin2 Tx	pin3 Rx	pin3 Tx	pin4 Rx	pin4 Tx
IC1	LM741	0	0	0	6,63	0	6,65	0	0
IC2	SA602	1,26	1,26	1,26	1,26	0	0	5	5,01
IC3	SA602	1,38	1,38	1,38	1,38	0	0	4,72	4,67
IC4	LM741	0	0	6,33	0	6,33	0	0	0
IC5	LM386	1,3	0	0	0	0	0	0	0

IC Ref.	Type	pin5 Rx	pin5 Tx	pin6 Rx	pin6 Tx	pin7 Rx	pin7 Tx	pin8 Rx	pin8 Tx
IC1	LM741	0	0	0	6,67	0,06	13,35	0,06	0
IC2	SA602	5,04	5	5,86	5,86	5,37	5,1	5,92	5,92
IC3	SA602	4,74	4,75	5,81	5,81	5,05	5,34	5,87	5,87
IC4	LM741	0	0	6,35	0	12,69	0	0,05	0
IC5	LM386	4,55	0	13,5	0,07	6,72	0	1,29	0

Tr Ref.	Type	B Rx	B Tx	E Rx	E Tx	C Rx	C Tx
Q1	BC547	0	0,78	0	0	0	0
Q2	BC547	3,8	3,8	3,92	3,92	7,95	7,95
Q3	BC547	3,5	3,5	4,01	4,01	7,95	7,95
Q4	BC547	3,85	3,85	3,67	3,67	7,95	7,95
Q5	2N2222	0	1,63	0	1,03	0	13,5
Q6	BD135	0	2,32	0	1,7	13,5	13,5
Q7	2SC5739	0	0,62	0	0,01	13,5	13,5

VCC = 13.5V Aproximated values +/-10% can be considered correct.

Limited WARRANTY

Please read carefully BEFORE building your kit

All components and hardware supplied as parts of a kit are warranted to be from manufacturing defect for one year from date of purchase. Except the TX output transistor.

The original purchaser has the option of examining the kit and manual for 10 days. If you choose within this period not to construct the kit, you may return the entire unassembled kit at your own expense for full credit toward any other kit, or refund, less original shipping/handling charges. The price of the kit that is attributable to sales fees mediation or payment system, will not be returned by the seller. ("ebay", "paypal" commission etc).

Please, BEFORE you make a return, email to: ea3gcy@gmail.com.

Javier Solans, ea3gcy warrants this device to function as described in this documentation provided that it is assembled and used correctly in accord with all printed directions. It is your responsibility to follow all directions in the instruction manual, to identify components correctly and to use good workmanship and proper tools and instruments in constructing this kit.

REMEMBER: This kit will not work as a commercial manufacturing set, however, can often give similar results. Do not expect great performance, but it sure is fun a lot!

If you believe a kit part is missing, do a thorough sorting of all parts, checking each off on parts list in the manual. Check all bags, envelopes or boxes carefully. Simply e-mail me or write, and I will promptly replace any missing part. Even if you find an exact replacement part locally, please notify us so we may assist other customers.

I can also supply any parts, hardware or wire that you have lost or broken.

If you find any errors in this manual or would like me any comments, do not hesitate to contact me at:

ea3gcy@gmail.com

Can see: www.qsl.net/ea3gcy

Thanks for building the ILER-40 Kit SSB Transceiver

Enjoy QRP !

73 Javier Solans, ea3gcy

SCHEME

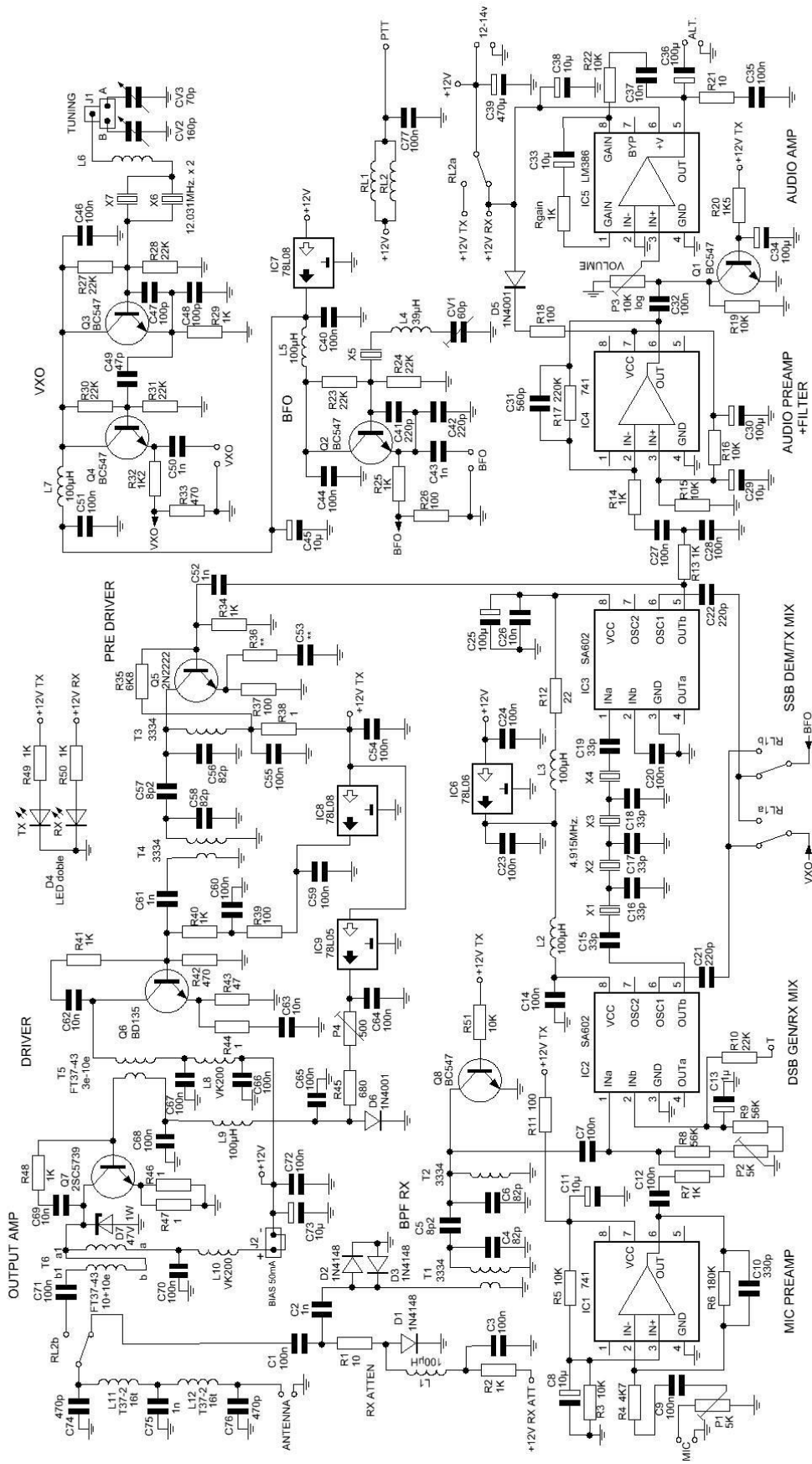

WIRING

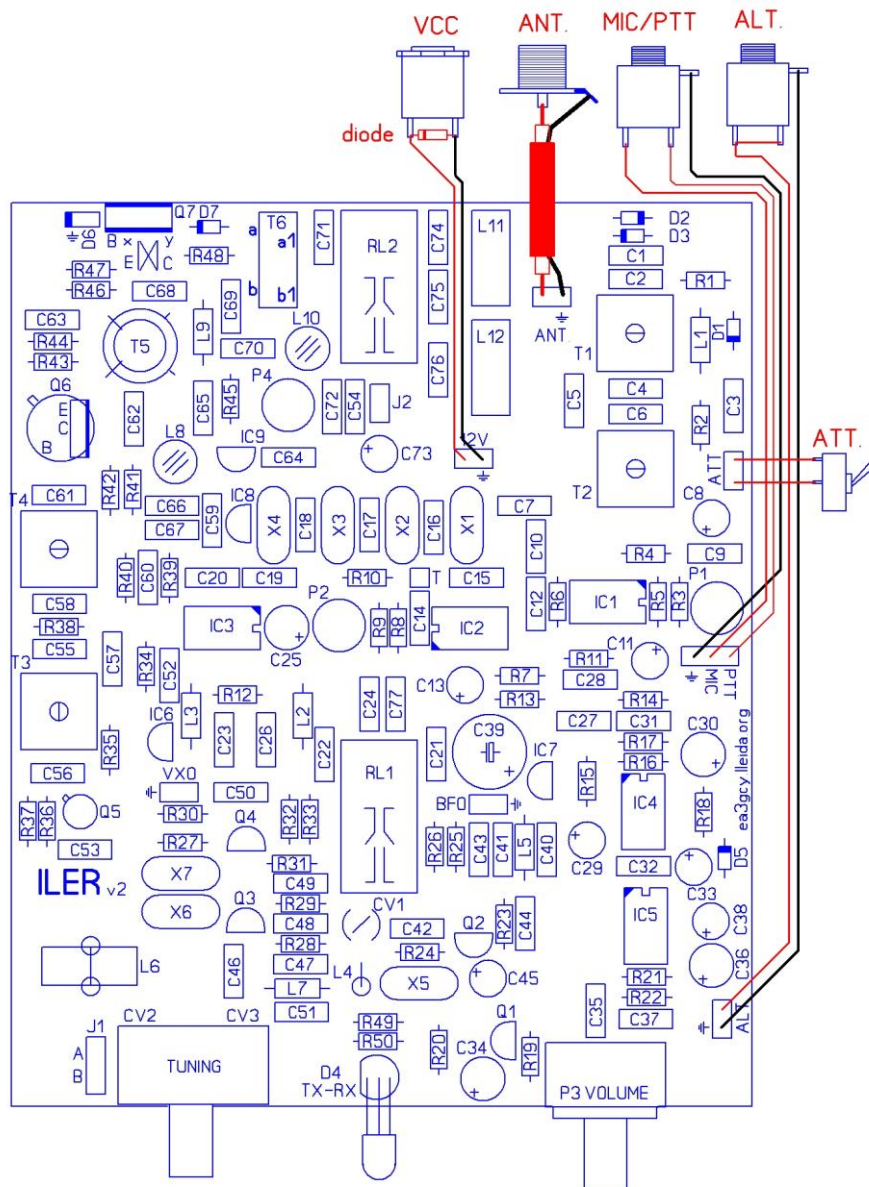

The wiring of Iler-40 is very simple, just remember that:

- For the connection of coaxial cable antenna use thin cable such as RG-174 or similar.
- If you install the tuning polyvaricon off the board, you should use rigid and short cables. Mechanical stability is very important.
- We recommend using a metal box.

The Iler-40 is not protected against possible failures of reverse polarity!

A good idea is to place a diode (ex. BY255 or longer) in parallel at the power supply input of Iler-40. The cathode (the end of the diode which has a painted band) goes to the positive pole. If your power supply is short-circuitable or fuse is fitted in the output, perfect, if not, build or purchase a cable with serial built-in fuse.